

The new dimension of injection molding Machines in the GX Series

Engineering Passion

Krauss Maffei

Facts and figures regarding the GX Series

Application areas



Consumer goods



Packaging



Automotive industry



Medical/pharmaceutical industry



Electrical engineering/electronics industry



Transport packaging

Clamping/injection matrix

Machine model / clamping force [t]	Clearance [h x v] mm	Injection units (screw diameter in mm)																				
		SP 1400			SP 2000			SP 3000			SP 4300			SP 6100			SP 8100			SP 12000		
		55	60	70	60	70	75	70	80	90	80	90	100	85	95	105	95	105	115	105	120	135
GX 400	920 x 830	■	■	■	■	■	■	■	■	■	■	■	■									
GX 450	920 x 830	■	■	■	■	■	■	■	■	■	■	■	■									
GX 451	1055 x 925	■	■	■	■	■	■	■	■	■	■	■	■									
GX 500	1040 x 910				■	■	■	■	■	■	■	■	■	■	■	■						
GX 550	1040 x 910				■	■	■	■	■	■	■	■	■	■	■	■						
GX 551	1130 x 980				■	■	■	■	■	■	■	■	■	■	■	■						
GX 600	1110 x 960				■	■	■	■	■	■	■	■	■	■	■	■	■	■	■			
GX 650	1110 x 960				■	■	■	■	■	■	■	■	■	■	■	■	■	■	■			
GX 651	1200 x 1020				■	■	■	■	■	■	■	■	■	■	■	■	■	■	■			
GX 750	1180 x 1000										■	■	■	■	■	■	■	■	■	■	■	■
GX 900	1180 x 1000										■	■	■	■	■	■	■	■	■	■	■	■

The new dimension of injection molding

Engineering inspired by passion. First-class machine concept. Best results.

Use to your advantage the first-class hydromechanical dual platen concept of the GX Series in conjunction with the single-piston injection system. Thanks to the modular design, the compact dual platen clamping unit can be individually configured with all available injection units. You also profit from the unique and intelligent production innovations: The GearX locking mechanism and the GuideX guide shoe.

Highlights of the GX Series at a glance:

Powerful thanks to:

- Very fast dry cycle time (2.3 seconds**)
- High precision with maximum dynamic performance
- Minimum energy consumption

User-friendly thanks to:

- Outstanding accessibility
- Fast mold set-up
- Intelligent, user-friendly control system

Value proven thanks to:

- Robust clamping and injection unit
- Low maintenance costs
- Simple retrofitting

Experience the new dimension A fascinating tour of the GX injection molding machine

Excellent dual platen technology

Top quality and maximum
productivity

GearX and GuideX product innovations

for fast locking and high part quality



Optimum accessibility

Short set-up times, easy
maintenance



Ideal interaction between automation and machine

Proven economical overall concept

New MC6 control system

Simple and clear operation with SplitScreen, ProcessDesigner and Eco function

Flexibility through modularity

Clamp, injector and drive unit can be individually combined

Powerful injection unit with proven plasticizing system

Maximum reproducibility and high melt quality

The modular GX concept At a glance



GearX locking device



GuideX guide shoe with linear guides



MC6 control system

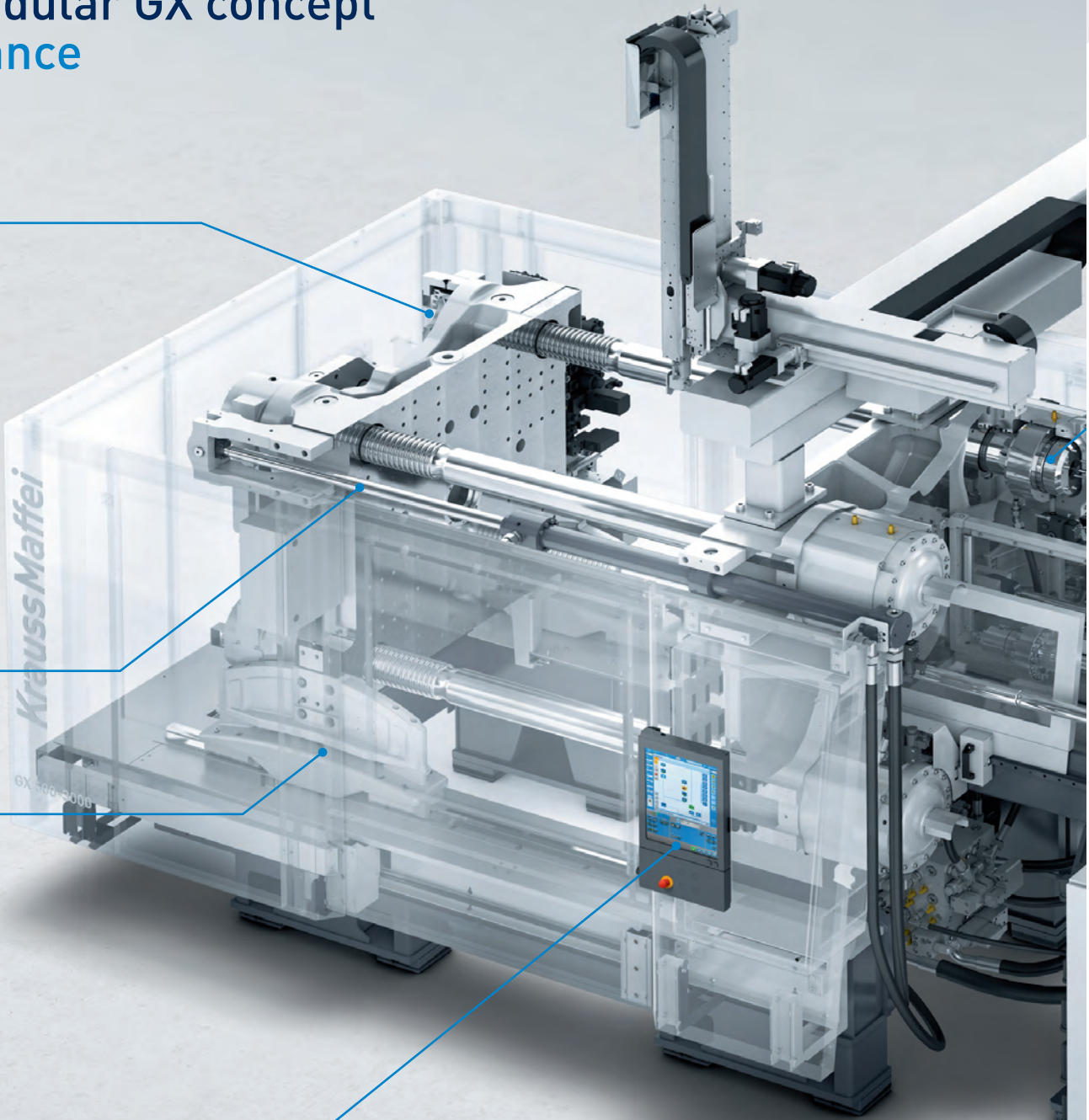

Movement cylinder

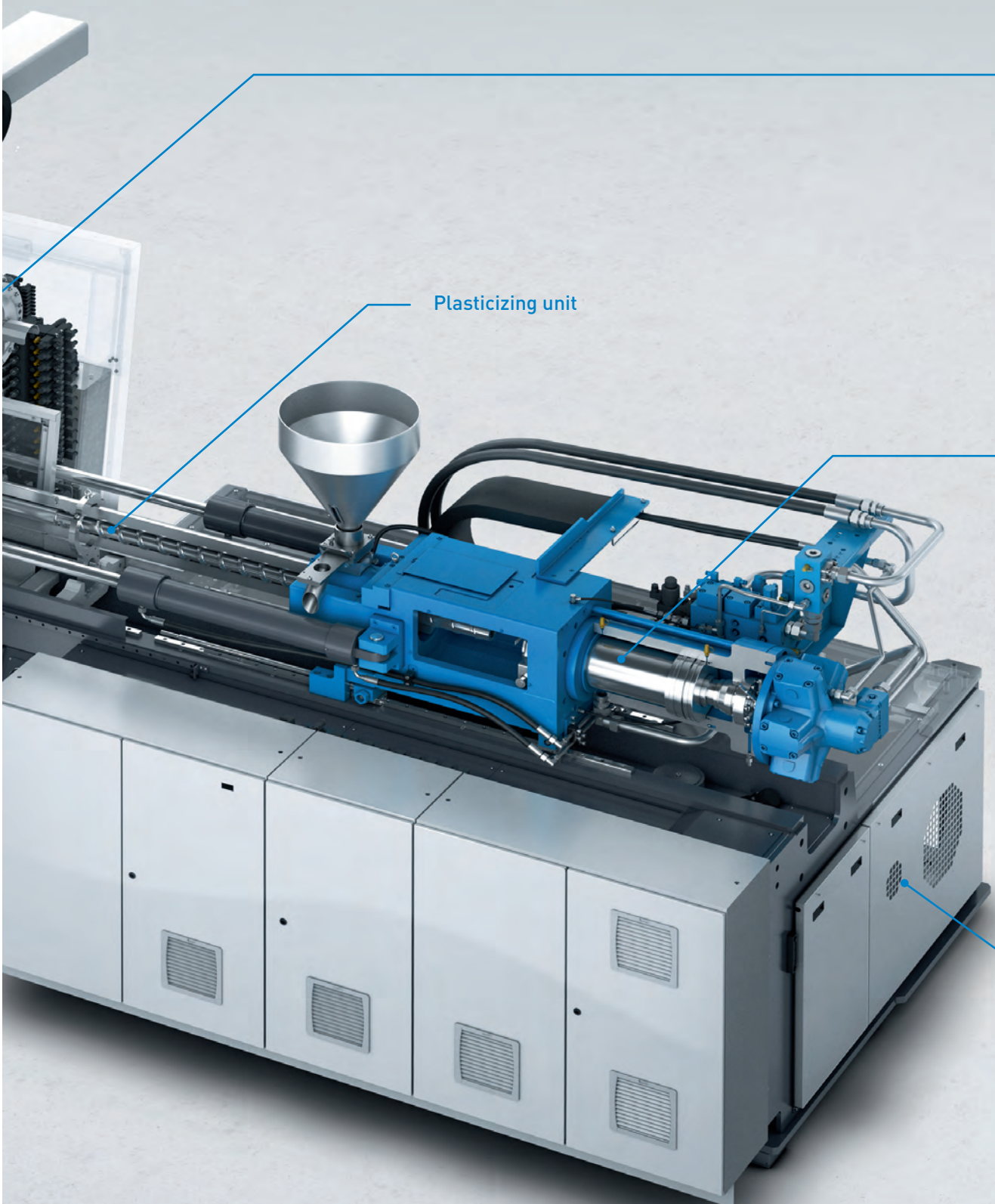

Plasticizing unit

Pressure pads

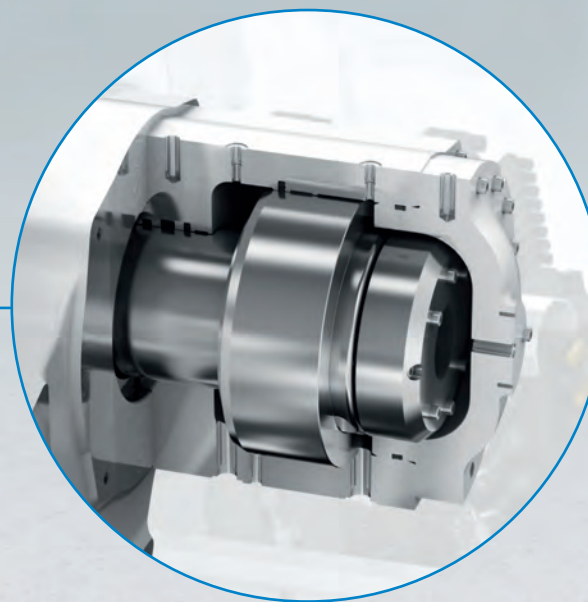

In-line injection unit



Power pack and pump area



Excellent dual platen technology

The powerful GuideX and GearX team ensures fast locking and excellent part quality

The hydromechanical dual platen clamping unit in the GX machine sets new standards in terms of quality and productivity. With the ingenious GuideX guide shoe, forces are ideally absorbed and the service life of the molds is increased. The innovative GearX locking device functions immediately and reliably.

GuideX guide shoe – the intelligent machine element for absolute platen parallelism with high force absorption

As an intelligent fixed bearing joint with an optimized FEM design, the GuideX guide shoe is a genuine highlight in the GX Series. Its stable design is the basis for the machine's outstanding platen parallelism.

Thanks to the innovative technology, the greatly reduced forces are transmitted to the linear guides. This keeps the guides protected over the long term and maintains their precise ease of movement. The movements are optimal in terms of energy usage and the sensitive mold area protection can achieve its full effect.

Fast locking thanks to GearX

GearX locks the machine within the shortest possible time. The locking element is positively engaged in the tie bar notches via a short flux of force inside the unit. The enclosed locking unit is located behind the moving mold fixing platen and is permanently protected. Thanks to the optimized and no-frills design, accessibility to the ejection area remains habitually spacious and clear.

Depending on the need, customer-specific ejector hole patterns, ejector plates, unscrewing units or rotary distributors can be placed flexibly behind the moving platen.



The GuideX guide shoe absorbs forces and protects the guides. The linear guide therefore permanently maintains its lightness and precision.

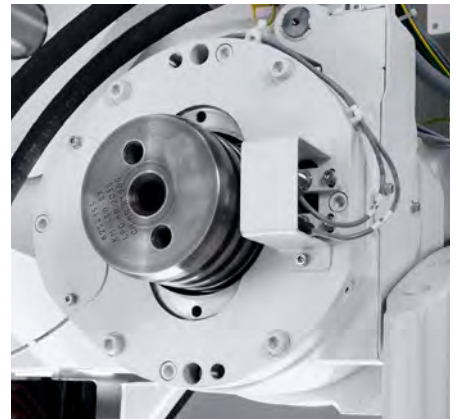

The new GearX locking device is quick and reliable.

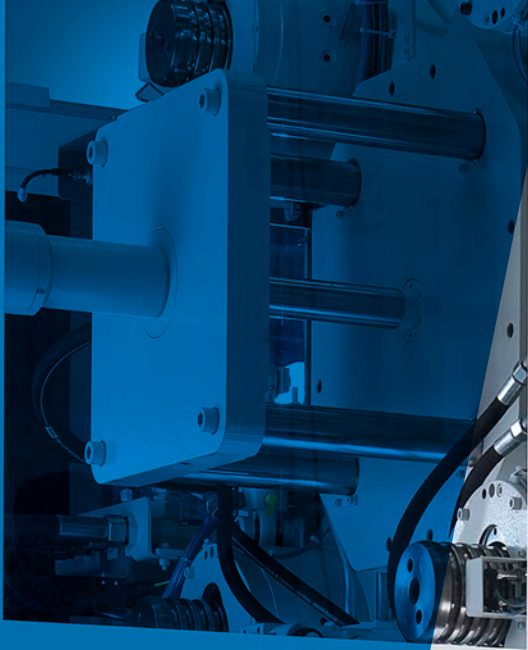

Together with GearX and GuideX, the hydromechanical dual platen clamping unit ensures high part quality and productivity



Clamping force - quick and energy-efficient with the "BluePower" optimized clamping block

The clamping force is built up through four pressure pads behind the permanent mold fixing platen. The refined running surfaces and seals in the pressure pads are specially designed for high permanent operation as a result of their material pairing. One of the impressive features of the new energy-efficient clamping block is its speed in building up and reducing clamping force.

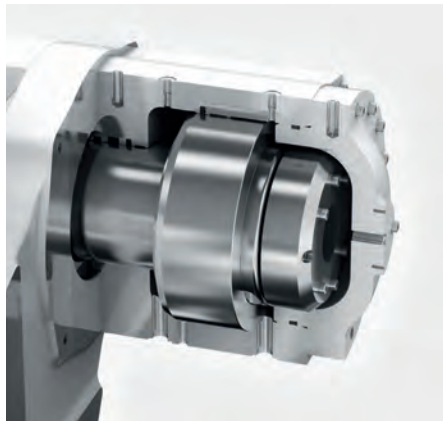

Long service life of the seals thanks to refined running surfaces.

Stable, permanently precise mold platens guarantee the highest possible part quality

Excellent stiffness is ensured through the cast-optimized mold fixing platens with a rib structure. The rigid central node, the diagonal ribs and the large distances between the tiebars permit the installation of small, medium-sized and large molds.

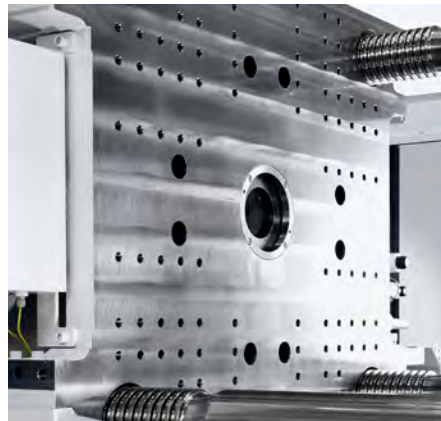

Cast-optimized platens are the basis for maximum part quality.

Thanks to the coherent overall concept of the GX clamping unit comprising platens, a clamping bed and GuideX, all occurring forces are ideally distributed. Your molds are therefore permanently protected.

Your advantages:

- Short dry cycle time [2.3 seconds*]
- Space-saving clamping unit
- Maximum part quality
- Minimum energy consumption
- Outstanding accessibility
- Service-friendliness

* Applies to the GX 450 according to the KraussMaffei standard

Excellent dual platen technology

Mode of operation of GuideX and GearX

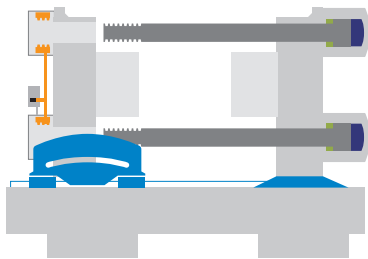

Open clamping unit

Thanks to the intelligent GuideX guide shoe, absolute platen parallelism is attained even with extremely heavy molds.

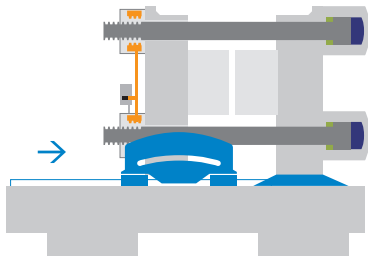

Clamping movement

In conjunction with the linear guides, GuideX produces almost friction-less mold movements. The roller guide impresses through its precision and ease of movement.

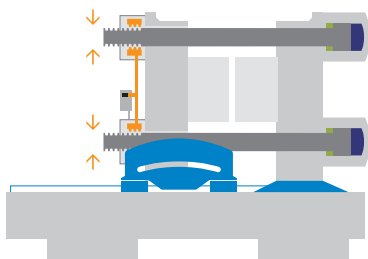

Locking

Thanks to GearX, the machine is locked quickly and reliably. When they interact with one another, the new GuideX and GearX technologies produce an extremely energy-efficient clamping principle, precise mold movements and quick dry cycle times.

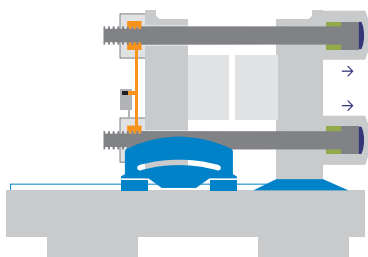

Build-up of clamping force

The clamping force is built up quickly with exact reproducibility through the pressure pads. The intelligent design of GuideX protects the linear guide against overloading and guarantees its long service life.

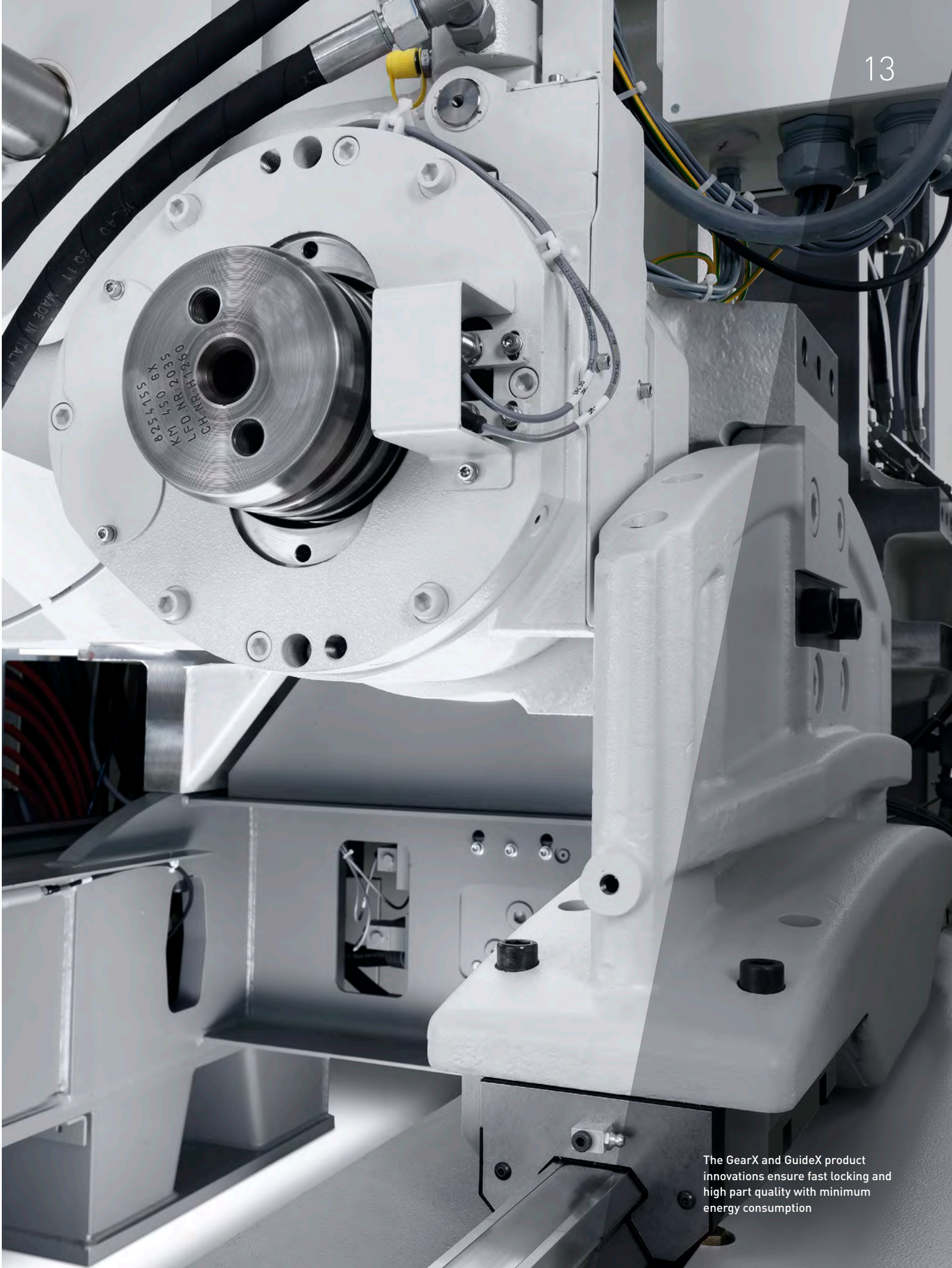

The GearX and GuideX product innovations ensure fast locking and high part quality with minimum energy consumption

Powerful injection unit with proven plasticizing system For maximum reproducibility with optimum melt quality

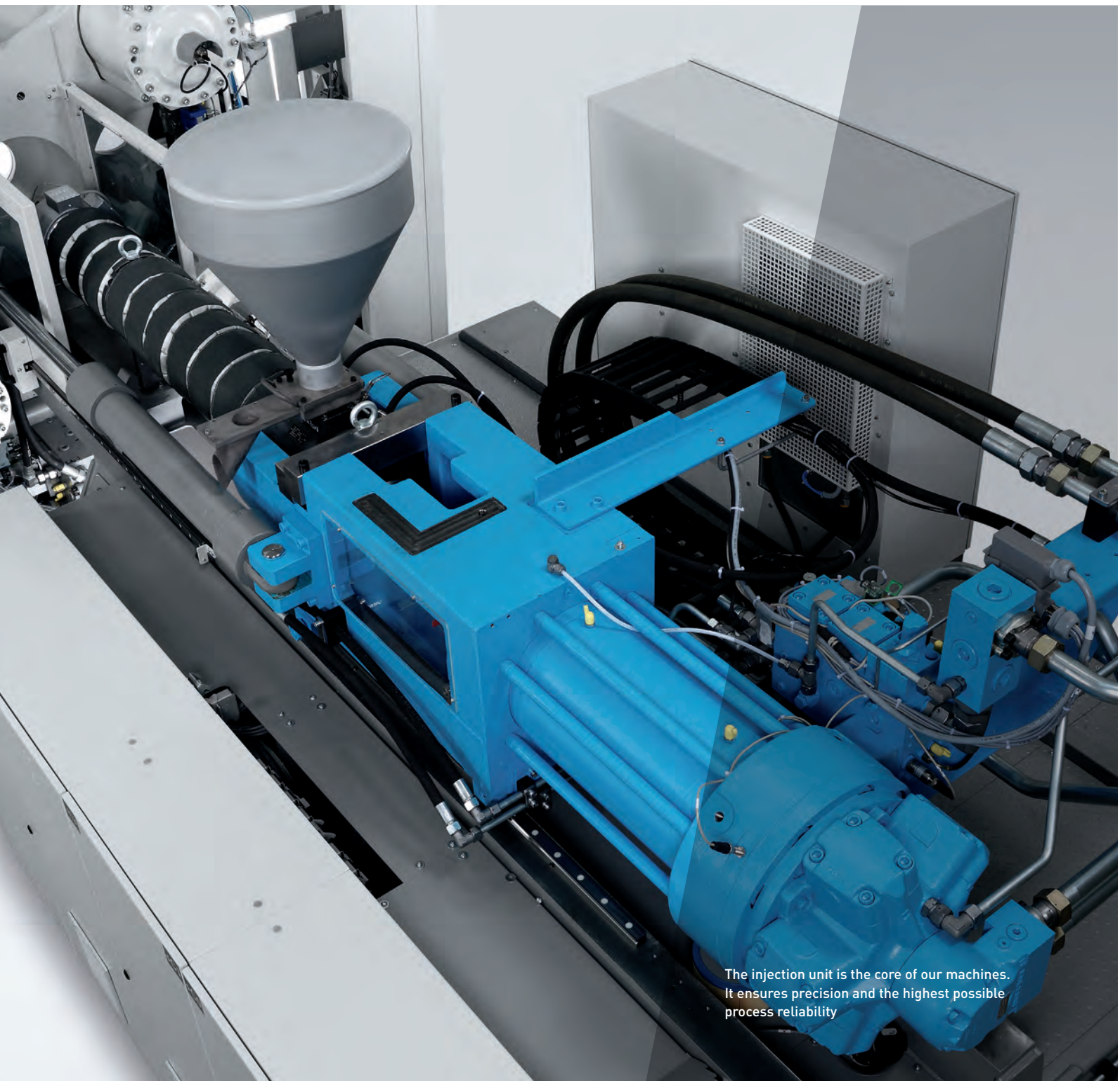

The injection unit is the core of our machines. It ensures precision and the highest possible process reliability



Linear force transmission ensures maximum shot weight constancy

Maximum shot weight constancy with optimum reproducibility

Profit from unlimited precision – the proven in-line injection unit with its rotary piston design transmits the force centrally via the injection piston to the screw. This direct path ensures absolute precision and maximum reproducibility. Injection regulation of pressure and speed is a standard feature of the GX and guarantees you maximum process reliability.

High throughput with outstanding melt quality

Our plasticizing systems are characterized by their excellent melt quality and cover a wide range of applications for different plastics. The GX plasticizing system can be exchanged with other KraussMaffei series. Our many years of experience and technology expertise in coordinating complex processes during plasticizing ensure high melt specifications with corresponding throughputs and optimum melt quality. The right choice of melt system leads to improved quality of your products and higher value retention.

The right screw for every plastic

In order to provide an ideal solution for the processing demands with different polymers, we have developed material- and processing-specific plasticizing systems.

In addition to outstanding melt quality and high throughputs, high-tech plastics mostly require additional wear resistance against adhesion, abrasion and corrosion in order to extend their service life. Depending on the part requirement, special plasticizing systems containing specific screws, check valves and cylinder fittings are available to you. Extract from our wide range of plasticizing solutions for processing:

- PC and PMMA materials,
- Short- and long-fiber-reinforced plastics,
- Blends,
- Thermosets and silicones

With our core competence, i.e. plasticizing, there are practically no limits to your material-specific requirements.



As a plasticizing specialist, our product range contains the right screw for you for every material

Your advantages:

- Outstanding shot weight constancy
- High process reliability
- Longer service life
- High expertise with special polymers
- Core competence with plasticizing systems
- Fast plasticizing change

Shot weight constancy

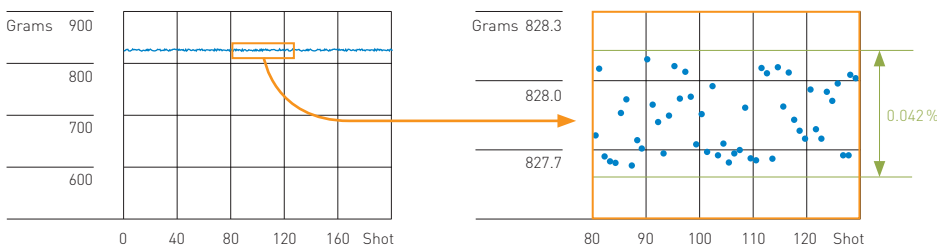

Shot weight constancy 0.042% based on the example of box covers with a shot weight of 828 g (polypropylene) and a cycle time of 39 seconds

Usability is our top priority

The new MC6 control system with SplitScreen technology, ProcessDesigner and Eco function

With innovative features such as SplitScreen technology, the MC6 control system offers you greater convenience and usability





Do you get the most energy-efficient machine setting?
Always! - Simply press the Eco button

The new MC6 control system meets all of your usability needs.

Whether you are working with a KraussMaffei control system for the first time or you are accustomed to its MC5 predecessor – MC6 technology is so intuitively accessible that you will work better and more efficiently than ever before.

Everything in sight - thanks to the new SplitScreen technology

SplitScreen technology is one of the special highlights of the MC6: Thanks to the split-screen display, you can see the most important production processes simultaneously. In parallel with the actual value cycles, you can control, for example, the injection process.

Clarity thanks to the ProcessDesigner tool

The integrated ProcessDesigner tool provides a clear visual presentation of all current processes and enables you to modify them, depending on requirements, by means of simple drag-and-drop movements or swiping movements.

Destination reached with just two taps – thanks to a drop-down menu and a favorites bar

To ensure that handling the control unit is as user-friendly as possible, deeper navigation levels have generally been avoided with the MC6. Based on the credo "reaching the destination as quickly as possible", a clear overall concept with individually configurable favorites bars is produced. In order to guarantee optimum use, the machine keypad only provides the keys which can be selected in regard to the operating states of the machine. Our user-

friendly principle is rounded off by a special field for selecting systems. You can therefore directly select all components of the machine up to automation and technology.

Go Eco! Energy efficiency at the push of a button

In keeping with our overall energy-efficient design, the MC6 control system has an "Eco button". This allows you to configure the machine in the most energy-efficient manner at the touch of a button.

Intelligent user profiles

Thanks to standardized role profiles – from the machine operator and mold setter through to the production manager – you can assign different authorizations quickly and easily. Of course, you can also create additional hierarchy levels and assign individual rights to users.

Another feature of the MC6 is the resistive dual-touch function which also allows the screen to be operated by a person wearing gloves. With the Windows 7 Embedded operating system, the MC6 is ideally equipped for today's technologies and those in future. The MC6 control system can be ordered in more than 30 languages. And best of all: Every feature is available not only with the control system, but also on the handheld pendant.

Your advantages:

- User-friendly function principle
 - Simple process control thanks to SplitScreen and ProcessDesigner
 - Clear structures
 - Standardized user administration
 - Two-way operation of automation and machine possible
-

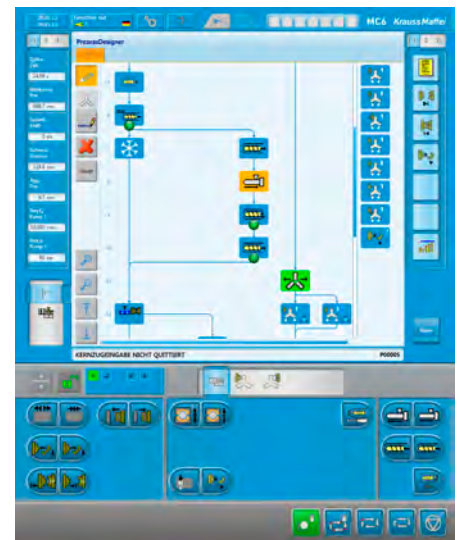

The MC6 control system impresses customers with its clear overall concept. Here using ProcessDesigner as an example.



You can operate the automation both from the handheld pendant and from the injection molding machine. And, with the MC6, even reverse operation of the injection molding machine is easy from the robot's hand-operated console.



Easy access to the pump area according to the quick click principle

The new maintenance concept of the GX allows quick and easy access to the most important hydraulic components. The standardized housing elements can be easily removed thanks to the quick click system. Nearly all the housing modules can be interchanged with one another.

Optimum accessibility

For fast set-up and easy maintenance

User-friendliness in a new dimension

The machines in the GX Series feature easy access to the shut-off, ejector and nozzle area, as well as to the switching cabinets and the pump area. Thanks to this accessible concept, you always work in an extremely convenient and time-saving manner.

The new dimension of accessibility has many positive sides

Direct access to mold-related interfaces: All cooling water connections, core puller valves, cascade control systems and the related interfaces for electric signals are arranged in fixed positions on the mold fixing platens. The interface for the hot-runner control stations is located on the operator's side. This extremely clear concept ensures clear structures and simple set-up.

Everything under control - thanks to an easy-to-install ejector area

The ejector area offers great freedom of movement, especially when coupling mold ejectors. The large doors provide easy access for set-up. The large observation windows actually allow optimum viewing during production.

Flexible parts removal

The machines (4000–6500 kN) are standardized for parts transportation on the operator's side, on the non-operator's side and in the direction of the machine with a chute. Depending on the production requirements, wide conveyors can be integrated and make non-automation production possible.

Nozzle change and cleaning made easy

Opening the movable and transparent safety gate creates a large space through to the nozzle area. The nozzle is therefore easily accessible and can be simply replaced or cleaned.

Fast production changeover for a fast-moving market

Using our quick mold clamping systems, plasticizing units can be changed quickly and easily so that you can immediately retool for the following process. The nozzle area is clearly visible and extremely easy to access. Even with lower shot weights, we can install a smaller plasticizing unit for you using an adaptation.

Your advantages:

- Optimized set-up times
 - Outstanding accessibility
 - Easy maintenance
 - Easy-to-see ejector area
 - Chute for freely falling parts
-



All of the important interfaces for the mold can be reached easily



The spacious ejector area is also suitable for special ejectors or turntables

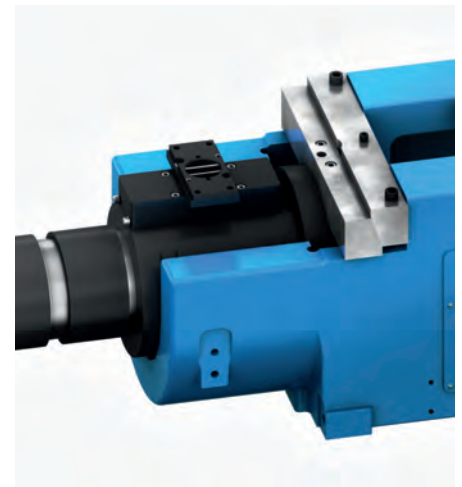

Our quick mold clamping system creates ideal conditions for a quick change of the plasticizing unit

Flexibility through modularity

The GX machine can be individually combined

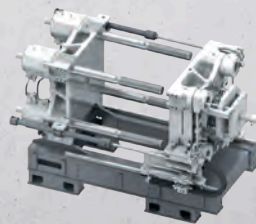
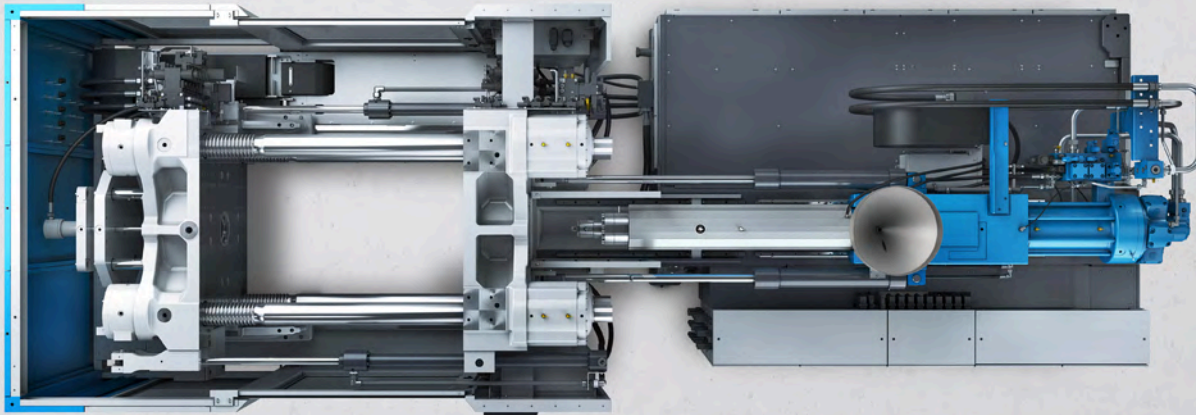

Clamping units



Injection modules



Drive modules

We can combine your GX machine precisely according to your requirements.

Profit from the flexibility, productivity and efficiency of our machine concept

The new modular system of the GX Series enables us to take account of your individual needs. Depending on which injection unit, clamping unit or drive unit you require, our modular machine concept enables us to precisely satisfy your requirements. Thanks to the constant height of the machine center, the modular system is compatible with all clamping/injection combinations.

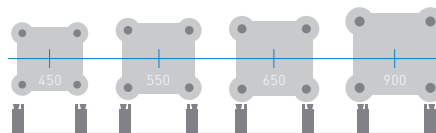

The height of the central axis remains identical in the GX, thus permitting a flexible combination of the injection and drive modules

Your advantages:

- Machine built according to the customer's requirements
- Energy-efficient drive systems [Potential savings: up to 50%]
- Premium quality hydraulics

The PowerPack concept Energy-efficient drive units for every need



The PowerPack drive unit contains the option of integrating servo drives in your machine and saving a large amount of energy

The new PowerPack concept improves productivity and increases energy efficiency

In the modular drive system of the GX Series, the latest generation of the variable delivery pumps is a standard feature. Their use improves efficiency and guarantees you maximum cost-effectiveness. The parallel movement of the ejector and core pullers increases productivity and is available as an optional extra. The new premium quality hydraulic components were designed with the focus on higher availability and a long service life to meet the latest state of the art regarding energy efficiency.

Depending on the application and production cycle, the machines can be supplied with different PowerPack performance classes for first-class economical production.

"Blue Power" efficiency solution – "Servo Drive Technology"

Through the optional use of "Blue Power Servo Drive" Technology, energy consumption is further optimized compared with variable delivery pumps. The saving amounts to 10 and 30 percent depending on the particular application. Compared with conventional hydraulic concepts on the market, savings of up to 50 percent

are actually possible. Another positive secondary effect is the lower noise level of servo drives.

KraussMaffei

GX 500-3000



Ideal interaction between automation and machine

Proven overall economic concept

Our extensive know-how in the areas of injection molding machinery and automation is your economic advantage. Standardized elements combined with customer-specific solutions form the basis for high flexibility in production. The integrated CE-approved safety concept ensures a high safety standard and reduces the machine costs.

Maximum variability thanks to standardized automation systems

The linear robots from the LRX Series are ideally suited for simple pick & place solutions and quick removal. They also perform a very wide range of tasks in the injection molding process: Insertion, demolding, processing and much more besides. Thanks to integration in the control unit of the machine, all work steps can be very easily programmed and saved with the dataset of the injection molding machine. This automatically ensures the right combination of dataset and program – an advantage which also considerably increases machine safety.

Unlimited opportunities with the KraussMaffei industrial robot

The industrial robot (IR) guarantees maximum flexibility during complex demolding and a wide range of other assembly steps or production steps. The intelligent control system concept featuring a simplified user interface and an extended expert mode is suitable for every user group and helps you reach your goal with often just two clicks. The user interface of the handheld pendant can also be selected in the beginner mode or expert mode depending on the user authorization and hierarchy.

WizardX – Smarter programming

The dialog-based programming assistant in the MC6 control system allows even beginners to create basic demolding processes in the shortest possible time. The interactive communication between the user and control system makes manual programming superfluous and eliminates programming errors.

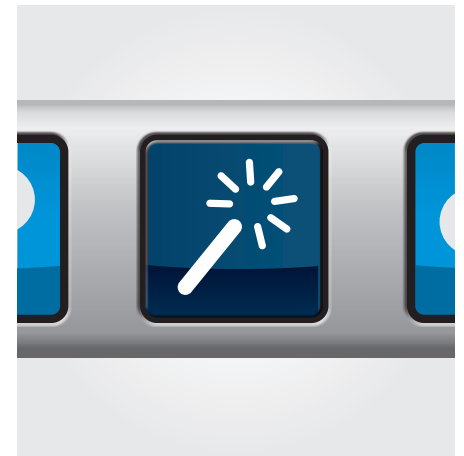

WizardX programming assistant
Easy to recognize by the „magic wand symbol“

Ideal interaction between automation and machine

Combination options



Linear robot

Machine model / clamping force (t)	LRX 150 (payload: 15 kg)			LRX 250 (payload: 25 kg)			LRX 350 (payload: 35 kg)			LRX 500 (payload: 50 kg)		
	X [mm]	Y [mm]	Z [mm]	X [mm]	Y [mm]	Z [mm]	X [mm]	Y [mm]	Z [mm]	X [mm]	Y [mm]	Z [mm]
GX 400	900	1800/T	2500	900	2000/T	2500	-	-	-	-	-	-
GX 450	900	1800/T	2500	900	2000/T	2500	-	-	-	-	-	-
GX 451	900	1800/T	2500	900	2000/T	2500	-	-	-	-	-	-
GX 500	900	1800/T	2500	900	2000/T	2500	-	-	-	-	-	-
GX 550	900	1800/T	2500	900	2000/T	2500	-	-	-	-	-	-
GX 551	900	1800/T	2500	900	2000/T	2500	-	-	-	-	-	-
GX 600	900	1800/T	2500	900	2000/T	2500	1200	2000/T	3000	-	-	-
GX 650	900	1800/T	2500	900	2000/T	2500	1200	2000/T	3000	-	-	-
GX 651	900	1800/T	2500	900	2000/T	2500	1200	2000/T	3000	-	-	-
GX 750	-	-	-	900	2000/T	3000	1200	2000/T	3000	1500	2500/T	4000
GX 900	-	-	-	900	2000/T	3000	1200	2000/T	3000	1500	2500/T	4000



Industrial robot (floor)

Industrial robot (console)

Machine model / clamping force (t)	IR 300	IR 1200	IR 900	IR 1200	IR 1500	IR 300	IR 300	IR 2100	IR 1800	IR 1500	IR 1200
	R2430 F/K	R2500 F/K	R2700 F/K	R2900 F/K	R3100 F/K	R2230 S/K	R2630 S/K	R2900 S/K	R3100 S/K	R3300 S/K	R3500 S/K
GX 400											
GX 450											
GX 451											
GX 500											
GX 550											
GX 551											
GX 600											
GX 650											
GX 651											
GX 750											
GX 900											

Key for industrial robot: IR = Industrial robot 300 = payload in N R2030 = reach in mm F = Floor S = Shelf type K = KUKA

Integrative system: The perfect symbiosis of a machine and automation technology

As a system partner, we supply automation technology and a machine on request as a fully integrated overall concept. The machine and handling system form a functional unit in this case. The joint control system allows both functional units to be controlled on any control panel: Automation technology and machine. The machine can be operated via the handheld pendant of the robot - and vice versa. The perfect symbiosis of a machine and automation technology is rounded off by a standard safety housing.

The control system: Intelligent and integrated

The injection molding process and automation form one unit via the integrated control system with VARAN-BUS technology. Process data are available in real time. Programming and operation are easy and do not call for any in-depth programming knowledge. To permit optimum teaching and ergonomic programming, all LRX/LRX-S machines have a handheld pendant with a touchscreen display whose user interface is identical with the machine's control panel.

With the integrated solution, the entire process can be controlled via a common operating panel. The machine and robot data are saved in one dataset. This also ensures maximum data security and excellent optimum operating convenience. 20 safety zones, of which 5 are dynamic, increase the efficiency of the control programs.

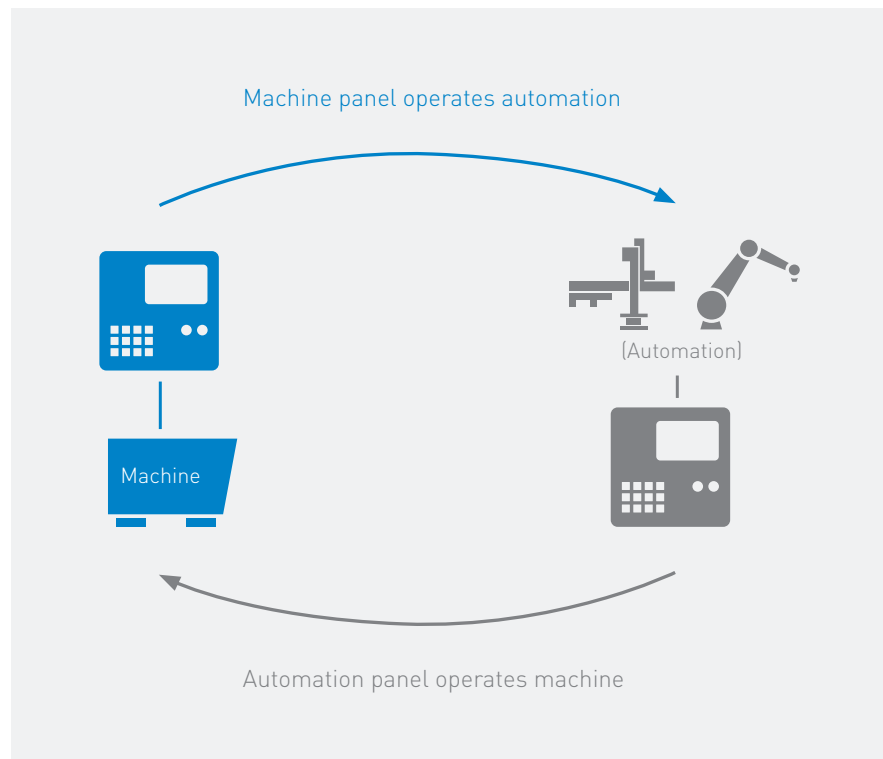

Work is made easier through mutual operation - the injection molding machine can be controlled by the automation handheld pendant - and vice versa

Your advantages:

- Smarter programming operation with WizardX
- Integrated control system with central operating unit
- Machine and automation system as optical and functional unit
- Standardized discharge and set-up options
- CE conformity
- Wide range of automation systems from pick & place to highly complex solutions

Further information which might also interest you

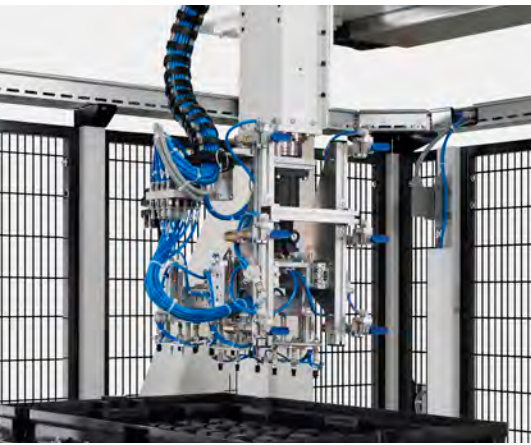

Are you looking for the appropriate automation solution for your GX machine?

We can offer you the right robot for every production task. You can also equip your GX machine with a special clamping system or various accessories.

We have also compiled extensive information on the subject of service for you.

You therefore increase the flexibility of your injection molding machines for constantly new process requirements and permanently extend their performance level. We are happy to provide you with detailed information on this.



Ask us for information about the following for example:

- Basis for economical production –
Linear robots in the LRX/LRX-S Series
- Flexible tools for productive automation –
Industrial robots in the IR Series
- Teleservice – the expert network
at the push of a button
- Life Cycle Service
Production partner

You can find our brochures and flyers on other topics online at: www.kraussmaffei.com.
On request, we would also be happy to send you the information and technical data free of charge.

KraussMaffei

A strong brand in a unique global group

Cross-technology system and process solutions

Whether in Injection Molding, Reaction Process Machinery or Automation – the KraussMaffei brand stands for pioneering and cross-technology system and process solutions in plastics processing worldwide. For decades, our expertise, innovative ability and passionate commitment to plastics engineering have been your competitive edge. As a cross-industry system provider, we offer you modular and standardized systems as well as solutions customized to your needs.

There for you around the world

With our worldwide sales and service network, we offer our international customers an excellent basis for a successful business relationship. Due to the close proximity to our customers, we are able to answer your individual inquiries very quickly. We work out the best possible technical and economical solution for your product and production requirements together with you. Test our machine technology for your applications and let our experts put together an individualized service package for you.

Individualized service

Our employees from customer service, application technology and service help you with your questions and needs on every topic dealing with machines, systems and processes – around the globe, quickly and with a high level of expertise. We have developed an extensive customized service spectrum with our lifecycle design, which accompanies you throughout the entire lifecycle of your machines and systems. Take advantage of the personal interaction and flexibility we offer in our practically oriented seminars. We carry out customer-specific trainings either at your location or at our sales and service locations.

You can find additional information about KraussMaffei at: www.kraussmaffei.com

KraussMaffei Group

Comprehensive expertise

Unique selling proposition Technology³

The KraussMaffei Group is the only provider in the world to possess the essential machine technologies for plastics and rubber processing with its KraussMaffei, KraussMaffei Berstorff and Netstal brands: Injection Molding Machinery, Automation, Reaction Process Machinery and Extrusion Technology.

The group is represented internationally with more than 30 subsidiaries and over ten production plants as well as about 570 commercial and service partners. This is what makes us your highly skilled and integrated partner. Use our comprehensive and unique expertise in the industry.

You can find additional information at: www.kraussmaffeigroup.com



The KraussMaffei Group has a global presence. Countries with subsidiaries are marked in dark blue. In the white-colored regions, the Group is represented by over 570 sales and service partners.

**Powerful.
User-friendly.
Value proven.
Machines in the GX Series**

Engineering inspired by passion.
First-class machine concept.
Best results.

The machines in our GX Series set new standards in terms of efficiency, user-friendliness and value retention. The excellent dual platen technology enables you to perform a quick clamping movement while you can substantially minimize your set-up times thanks to extremely simple accessibility. Absolute parallelism of the platens guarantees maximum precision and first-class part quality. Using our well-known powerful injection unit, you can obtain maximum reproducibility. However, there are even more advantages. You obtain a first-class, modular machine concept which features unique and intelligent product innovations: The GearX locking mechanism and the GuideX guide shoe.